

Linear

MOMO Bloc R020 Fixture Guide

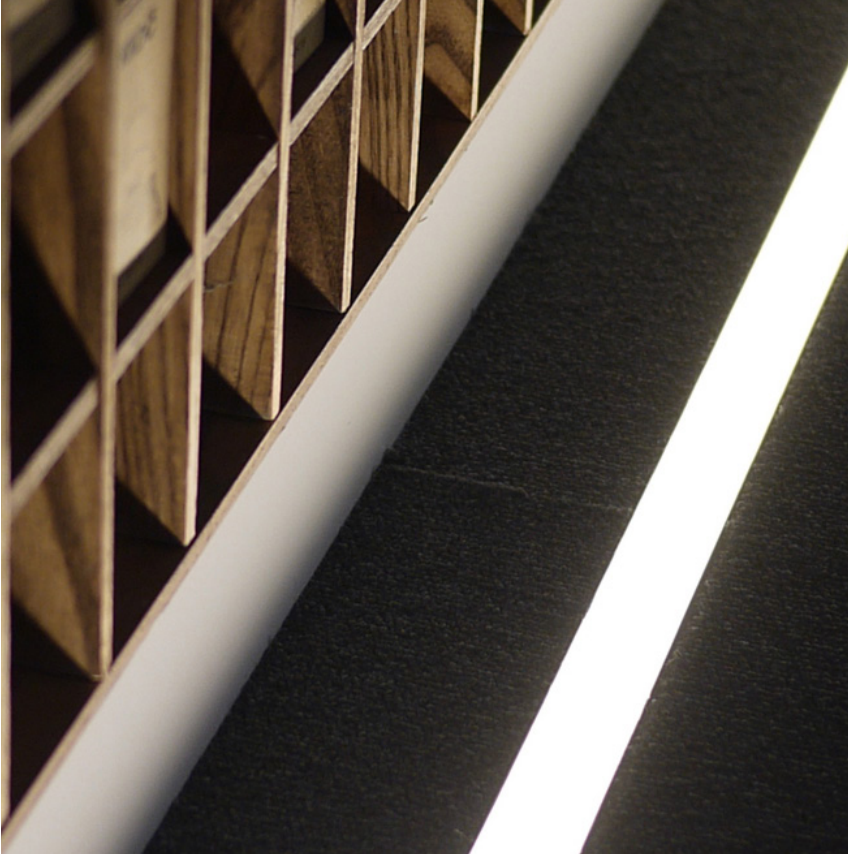

Indoor/Outdoor | Recessed | Output up to 444lm/m (135lm/ft)



Key applications

- ✓ Architectural detail
- ✓ Direct lighting
- ✓ Exterior
- ✓ In ground
- ✓ Orientation lighting
- ✓ Pathways/driveways
- ✓ Public spaces
- ✓ Uplighting
- ✓ Wall grazing

Key features

- ✓ Custom lengths
- ✓ Constant Voltage (CV)
- ✓ Continuous light runs
- ✓ Diffusion: homogenous
- ✓ Direct view
- ✓ IK08
- ✓ In ground driveover
- ✓ In ground walkover
- ✓ IP67 waterproof

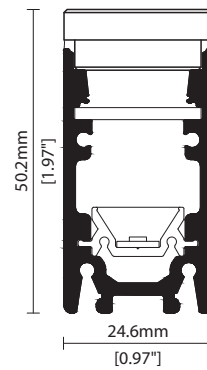

MOUNTING METHODS



KKBG-01 Ground box



KKBG-02 Ground box



KKBG-03 Ground box

Linear

MOMO Bloc R020

Specification sheet



Dimensions	H50.15/W24.6/L524/1024mm (H1.98/W0.97/L20.63/40.31in)
PCB Cut-point	41.7mm increment/2000mm max (1.64in increment/78.74in max)
LED Pitch	6.95mm-144LED/m (0.27in - 44LED/ft)
Chip	s-line k-line
Cover/Optics	Frosted glass (78°)
CCT	s-line: 2300K/3000K/3400K/4000K/4100K k-line: 2300K/3000K/3400K/4000K/4100K
LED binning	s-line: 2-step MacAdam ellipse k-line: 3-step MacAdam ellipse
CRI	≥ 90
Lifetime	50,000 hours @ 25°C (50,000 hours @ 77°F)
Operating temp	T _a = -25 to 50°C (T _c max = 82.9°C) T _a = -13 to 122°F (T _c max = 181°F)
IP Rating	IP67
Finish	Silver/Hard anodised (stainless steel ground box)
Mounting	Recessed ground box
Power feed	Sheathed hardwire tails or male/female connectors
Control	0-10V/1-10V/DMX/DALI
Drive over	EN 60598-2-13:2006+A1:2012 (Static load, Torque and Shear load testing)
IK Rating	IEC 62262:2010/IK08



LED Grading Key

Exclusive Grade

s **s-line***
2-step CCT range

*KKDC tuned
CCT range

Base Grade

k **k-line**
3-step commercial range
Energy Star CCTs

Power consumption	Supply voltage	Supply current
20W/m (6.10W/ft)	24V DC	0.83A/m (0.25A/ft)

Performance Data (3000K)

	R1	R2	R3	R4	R5	R6	R7	R8	R9	R10	R11	R12	R13	R14		
k-line	88	91	94	89	86	88	94	80	50	79	88	65	88	97		
	Frosted															
													CRI	R9	Rf	Rg
s-line	444lm/m (135lm/ft) 22.2lm/W											91	51	-	-	
k-line	418lm/m (127lm/ft) 20.9lm/W											90	50	-	-	

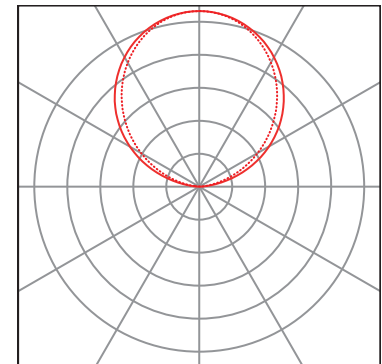
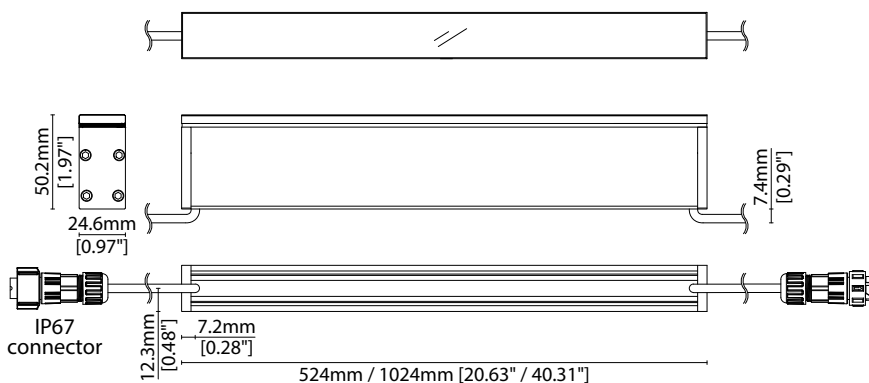

Frosted glass
— C0 / C180 cd / 1000 lm - - - C90 / C270

Data derived from independent UKAS / IESNA LM-79-08 accredited testing of production samples.

FIXTURE

Model	Finish	Cover ¹	Grade ²	LED	Colour (CCT)	Length Availability ³	IP	Cable Length	Power Feed ⁴	Input						
MOMO Bloc	Silver Anodised	SA Frosted Glass	M	s	R020	2300K (2100K PCB) ⁶	R020	m 524/1024mm i 20.63/40.31in	IP67	67	300mm/11.81"	0300	Single ø4.3mm sheath tail	S00A	DC 24V	g
					3000K (2500K PCB) ⁶	1000mm/39.37"					1000					
	Hard Anodised ⁵	HA	M	s	3400K (2700K PCB) ⁶	34	Single ø4.3mm sheath IP67 connector	S67A								
					4000K (3000K PCB) ⁶	40	Double ø4.3mm sheath IP67 connector	D67A								
					4100K (3200K PCB) ^{6,7}	41										

¹ Refer to **Cover/Lens Options** on **Options** pages

² Refer to **LED Grading Key** on **Specification sheet** page

³ Refer to **Length Availability List** or enter total run length instead of length code

⁴ Refer to **Power Feed Options** on **Options** pages

⁵ Hard anodised finish reduces light output by an average of 30%

⁶ Actual colour temperature after colour shift caused by silicone potting

⁷ 4100K (3200K PCB) is only available in k-line

Code Example:

BL	-	SA	-	M	-	s	-	R020	-	40	-	m	524	-	67	-	0300	-	D00A	-	g	
MOMO Bloc		Silver Anodised		Frosted Glass		s		R020		4000K (3000K PCB)		524mm		IP67		300mm/11.81"		0300		Double ø4.3mm sheath tail		DC 24V

ACCESSORIES

Mounting Accessories

KKBG-01	Ground box 01
KKBG-02	Ground box 02
KKBG-03	Ground box 03

* Refer to **Mounting accessories** on **Accessories** pages

Connection Accessories

CN67-2P-0300	IP67 2 PIN male & female 300mm/11.81" pair
CN67-2P-1000	IP67 2 PIN male & female 1000mm/39.37" pair
CN67-2P-3000	IP67 2 PIN male & female 3000mm/118.11" pair

* Refer to **Power feed** on **Accessories** pages

Exterior Junction Boxes

KKJB-07	IP67 Slim J-Box
KKJB-07R	Potting Resin for IP67 Slim J-Box

* Refer to **Exterior Junction Boxes** on **Accessories** pages

PSU/Driver

0-10V/1-10V/DALI/DMX

* Refer to **Driver/PSU Options** page for details or provide requirement and KKDC to offer the suitable option

LED ENGINE VARIANTS (LED STRIP TYPE)

Colour	LED	Lumen/m	Lumen/ft	W/m	W/ft	Spec Doc	Length
Single CCT	R007	145	44	7	2.13	MOMO Bloc R007	524/1024mm (20.63/40.31in)
	R014	300	91	14	4.27	MOMO Bloc R014	524/1024mm (20.63/40.31in)
	R020	444	135	20	6.10	MOMO Bloc R020	524/1024mm (20.63/40.31in)
RGB	501	Red 30 Green 88 Blue 14 RGB 127	Red 9 Green 27 Blue 4 RGB 39	15.6	4.75	MOMO Bloc RGB	524/1024mm (20.63/40.31in)

* Performance data: s-line, frosted glass, 3000K

MOMO Bloc R020

Length Availability List



Length Code		Fixture Length ¹		LED Strip ²		End Cap Dimension ³		Wattage (W)	Output (lm)
Metric	Imperial(US)	Metric	Imperial(US)	Metric	Imperial(US)	Metric	Imperial(US)		3000K (Test Data)
m0520	i0020	524mm	20.63in	500mm	19.69in	10mm	0.39in	10.00	209
m1020	i0040	1024mm	40.31in	1000mm	39.37in	10mm	0.39in	20.00	418

¹ Actual total overall length of light fixture (LED strip + end caps + void/wire hole)

² Actual length of PCB strip

³ Actual length of 2x end caps

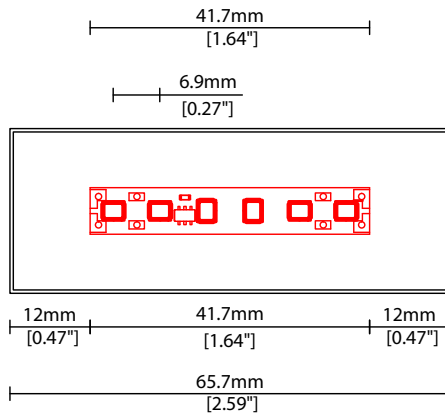

Linear

MOMO Bloc R020 Options



COVER/LENS OPTIONS

* Options are an integral part of the fixture ordering codes. Please refer to **Code Table** pages.

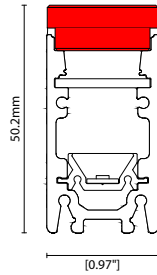

M Frosted Glass Cover
W24.6/H50.2mm (W0.97/H1.97")

POWER FEED OPTIONS

0300 S00A 300mm (11.81") Single Ø4.3mm sheath tail

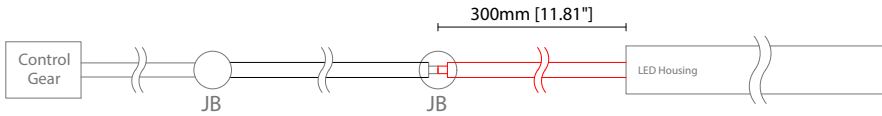

0300 D00A 300mm (11.81") Double Ø4.3mm sheath tail

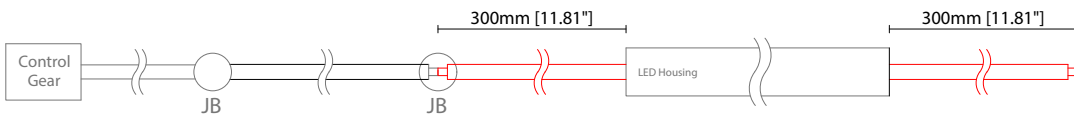

0300 S67A 300mm (11.81") Single Ø4.3mm sheath IP67 connector

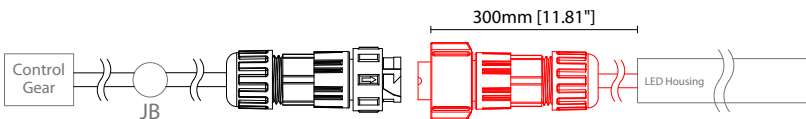

0300 D67A 300mm (11.81") Double Ø4.3mm sheath IP67 connector

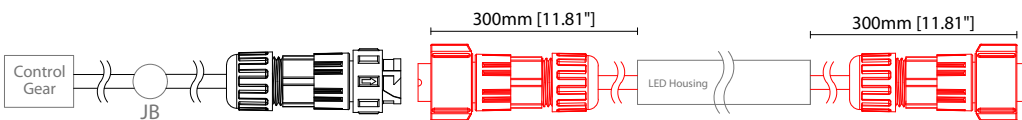

1000 S00A 1000mm (39.37") Single Ø4.3mm sheath tail

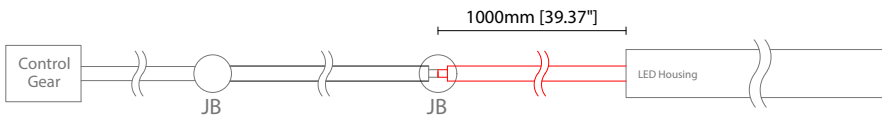

1000 D00A 1000mm (39.37") Double Ø4.3mm sheath tail

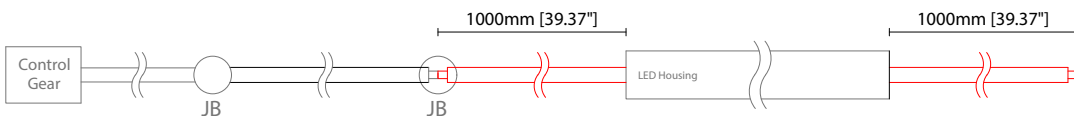

1000 S67A 1000mm (39.37") Single Ø4.3mm sheath IP67 connector

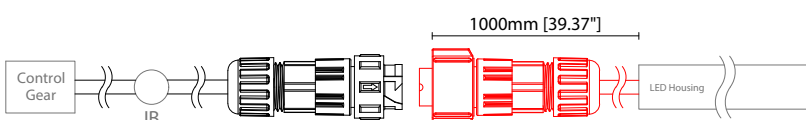

1000 D67A 1000mm (39.37") Double Ø4.3mm sheath IP67 connector

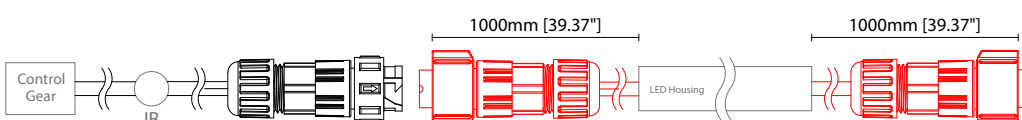

Key

Control Gear Power supply, sub-controllers & control systems
 JB Junction box / cable connection

Linear

MOMO Bloc R020 Options



POWER FEED OPTIONS (CONTINUED)

IP67 2 Pin Connector

Female connector
2 PIN (IP67)

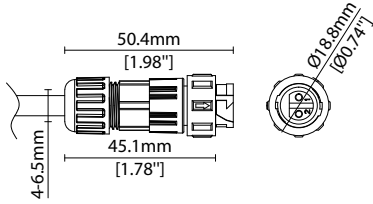

Male connector
2 PIN (IP67)

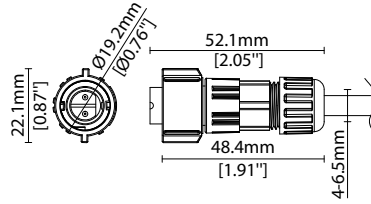

MOUNTING ACCESSORIES

Note: Accessories are to be ordered separately with corresponding code shown below.



KKBG-01 *
Ground box 01
Stainless steel finish
W79.1/H76.5mm (W3.11/H3.01")
* Specify length to match BLOC

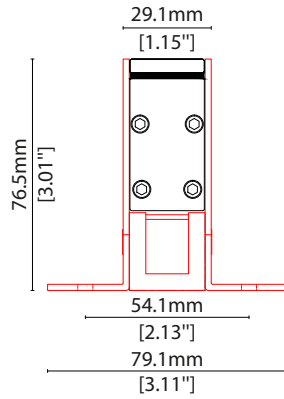

KKBG-02 *
Ground box 02
Stainless steel finish
W54.1/H76.5mm (W2.13/H3.01")
* specify length to match BLOC

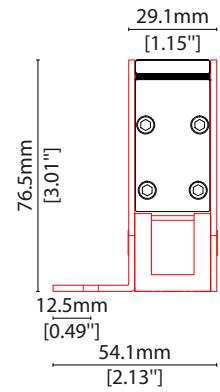

KKBG-03 *
Ground box 03
Stainless steel finish
W29.1/H76.5mm (W1.15/H3.01")
* specify length to match BLOC

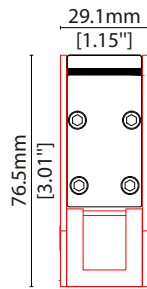

POWER FEED

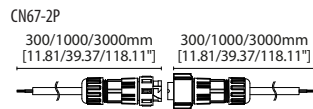

CN67-2P-0300 300mm (11.81in) pair
CN67-2P-1000 1000mm (39.37in) pair
CN67-2P-3000 3000mm (118.11in) pair
IP67
2 PIN male + female connector set

EXTERIOR JUNCTION BOXES



KKJB-07

IP67 Slim J-Box
(including type A,B,C, D bushings)



KKJB-07R

Potting resin for IP67 Slim J-Box

KKDC CONTROL



KKDM-06 1-10V

visDIM dimmable sub-controller
(4 x 8A max @ 12-36V)

IP20
Plastic housing
L170/W59/H29mm
(L6.69/W2.32/H1.14in)



KKSC-05 DMX

visDIM dimmable sub-controller
(4 x 5A max @ 12-36V)

IP20
Plastic housing
L170/W53.4/H28mm
(L6.69/W2.10/H1.10in)



KKDL-02 DALI

visDIM dimmable sub-controller
(4 x 8A max @ 12-36V)

IP20
Plastic housing
L170/W59/H29mm
(L6.69/W2.32/H1.14in)



KKDL-03 DALI

visDIM dimmable sub-controller
(4 x 5A max @ 12-36V)

IP20
Plastic housing
L166/W53.4/H23mm
(L6.54/W2.10/H0.91in)

AVAILABLE PSU OPTIONS

Control Mode	PSU (Order Code)	Input Voltage AC	Output Voltage DC	Rated Output Current	Rated Power	Dim %	IP Rating
Switched	CEN-60-24	90-295V	24V	2.5A	60W	-	IP67
	HLG-60H-24	90-305V	24V	2.5A	60W	-	IP67
	HLG-100H-24	90-305V	24V	4.0A	100W	-	IP67
	HLG-150H-24	90-305V	24V	6.3A	150W	-	IP67
	HLG-240H-24	90-305V	24V	10A	240W	-	IP67
0-10V (1-10V)	PWM-40-24	90-305V	24V	1.67A	40W	100-0.15 (100-10)	IP67
	PWM-60-24	90-305V	24V	2.5A	60W	100-0.15 (100-10)	IP67
	PWM-90-24	90-305V	24V	3.67A	90W	100-0.15 (100-10)	IP67
	PWM-120-24	90-305V	24V	5.0A	120W	100-0.15 (100-10)	IP67
DALI	LIN100A1	120-277V	24V	1A per channel	100W	100-0.1	IP66/IP40
DMX RGB	LIN100A1	120-277V	24V	1.33A per channel	100W	100-0.1	IP66/IP40
DMX RGBW	LIN100A1	120-277A	24V	1A per channel	100W	100-0.1	IP66/IP40

Flicker Free Options - Combination of PSU+ sub-controller

Control Mode	PSU (Order Code)	Sub-controller (Order Code)	Input Voltage AC	Output Voltage DC	Rated Output Current	Rated Power	Dim %	IP Rating PSU/ Sub-controller
0-10V or 1-10V	CEN-60-24	KKDM-06	90-295V	24V	2.5A	60W	100-0.9	IP67/IP20
	HLG-60H-24	KKDM-06	90-295V	24V	2.5A	60W	100-0.9	IP67/IP20
	HLG-100H-24	KKDM-06	90-295V	24V	4.0A	100W	100-0.9	IP67/IP20
	HLG-150H-24	KKDM-06	90-295V	24V	6.3A	150W	100-0.9	IP67/IP20
	HLG-240H-24	KKDM-06	90-295V	24V	10.0A	240W	100-0.9	IP67/IP20
DALI	CEN-60-24	KKDL-02/03	90-295V	24V	2.5A	60W	100-0.1	IP67/IP20
	HLG-60H-24	KKDL-02/03	90-305V	24V	2.5A	60W	100-0.1	IP67/IP20
	HLG-100H-24	KKDL-02/03	90-305V	24V	4.0A	100W	100-0.1	IP67/IP20
	HLG-150H-24	KKDL-02/03	90-305V	24V	6.3A	150W	100-0.1	IP67/IP20
	HLG-240H-24	KKDL-02/03	90-305V	24V	10.0A	240W	100-0.1	IP67/IP20
DMX RGB	CEN-60-24	KKSC-05	90-295V	24V	2.5A	60W	100-0.9	IP67/IP20
	HLG-60H-24	KKSC-05	90-305V	24V	2.5A	60W	100-0.9	IP67/IP20
	HLG-100H-24	KKSC-05	90-305V	24V	4A	100W	100-0.9	IP67/IP20
	HLG-150H-24	KKSC-05	90-305V	24V	6.3A	150W	100-0.9	IP67/IP20
	HLG-240H-24	KKSC-05	90-305V	24V	10.0A	240W	100-0.9	IP67/IP20

¹ The items shown above cover the most frequently used specification but does not exhaust the possible options

² PSU and/or driver can be chosen from the table, or KKDC may recommend the best option upon receipt of the controls requirement and installation environment

³ Electrical shop drawing will include detailed information of PSU and relevant control drivers

⁴ Cut sheets are available on the controls section of www.kkdc.lighting or upon request